

4041 & 4041DA PUSH SIDE (TOP JAMB) DROP PLATES PERMITS 120° MAXIMUM OPENING

**PUSH SIDE MOUNT ON:
4040-18TJ DROP PLATE
4040-18TJDS1 DROP PLATE**

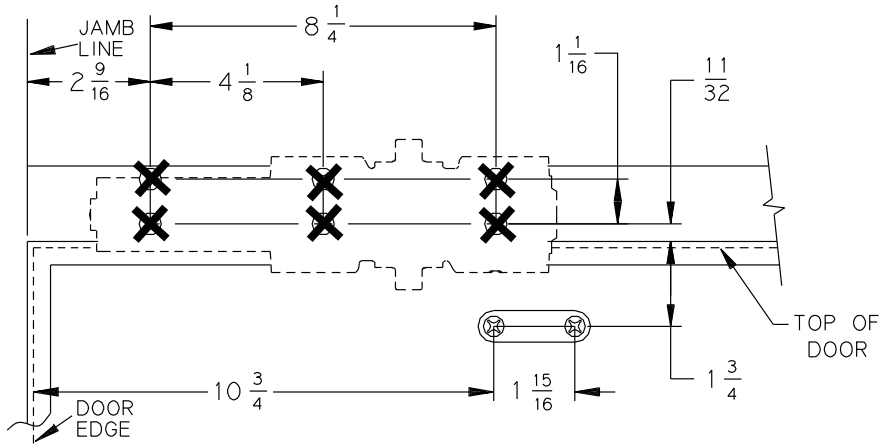

LEFT HAND DOOR SHOWN,
RIGHT HAND OPPOSITE.

MAXIMUM REVEAL OF 2 9/16.
FOR REVEALS 2 5/8 - 4 13/16
SPECIFY LONG ROD.
FOR REVEALS 8" SPECIFY EXTRA LONG ROD.

Locate drop plate & shoe from centerline of pivot or swing clear hinge pin when used.

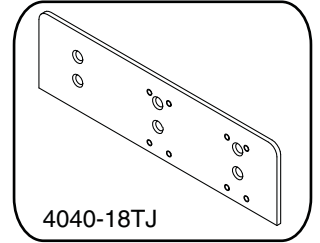

4040-18TJ

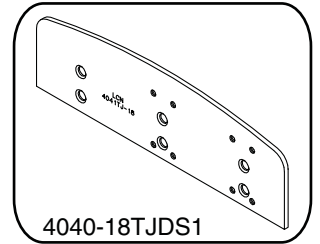

4040-18TJDS1

4041 & 4041DA PUSH SIDE (TOP JAMB) DROP PLATES PERMITS 120° MAXIMUM OPENING

**PUSH SIDE MOUNT ON:
4040-18G DROP PLATE**

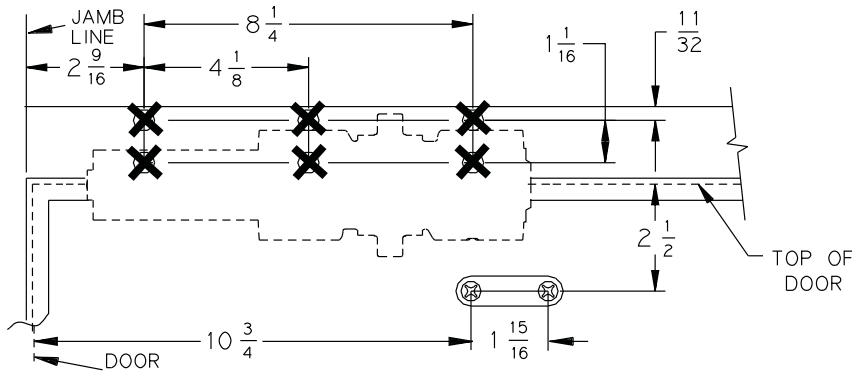

Locate drop plate & shoe from centerline of pivot or swing clear hinge pin when used.

LEFT HAND DOOR SHOWN,
RIGHT HAND OPPOSITE.

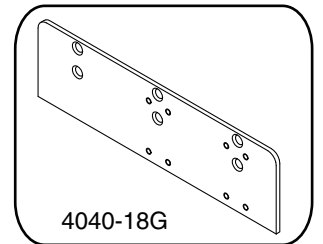

4040-18G

MAXIMUM REVEAL OF 2 9/16.
FOR REVEALS 2 5/8 - 4 13/16
SPECIFY LONG ROD.
FOR REVEALS 8" SPECIFY EXTRA LONG ROD.

4041 & 4041DA PULL SIDE (DOOR JAMB) DROP PLATES PERMITS 120° MAXIMUM OPENING

**PULL SIDE MOUNT ON:
4040-18 DROP PLATE
4040-18DS1 DROP PLATE**

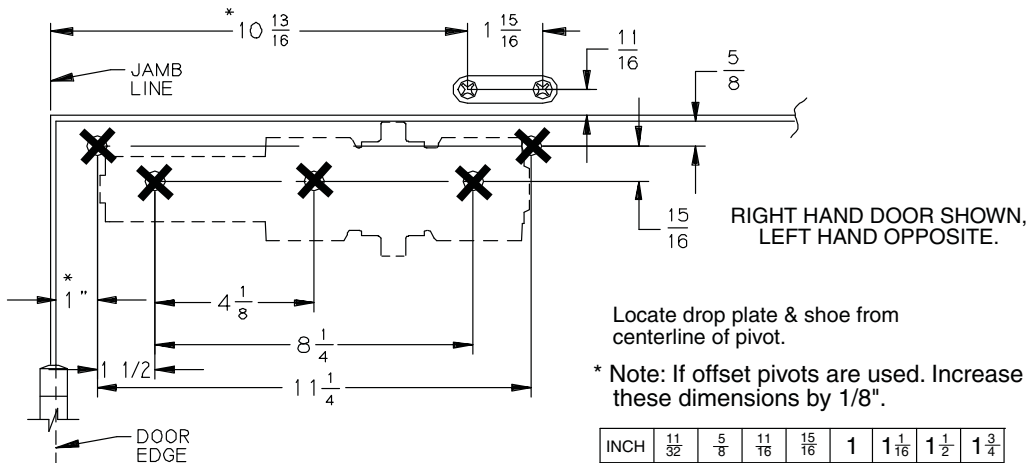

RIGHT HAND DOOR SHOWN,
LEFT HAND OPPOSITE.

Locate drop plate & shoe from centerline of pivot.

* Note: If offset pivots are used. Increase these dimensions by 1/8".

INCH	11/32	5/8	11/16	15/16	1	1 1/16	1 1/2	1 3/4
M.M.	9	16	17	24	25	27	38	44
INCH	1 15/16	2 1/2	2 9/16	4 1/8	8 1/4	10 3/4	10 13/16	11 1/4
M.M.	49	64	65	105	210	273	275	286

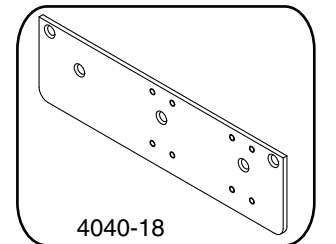

4040-18

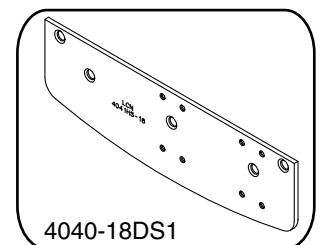

4040-18DS1



**4041PA PUSH SIDE (DOOR MOUNT) DROP PLATES
PERMITS 180° MAX. OPENING, BUTT SIZE 5x5 MAX.**

**PUSH SIDE MOUNT ON:
4040-18PA DROP PLATE
4040-18PADS1 DROP PLATE**

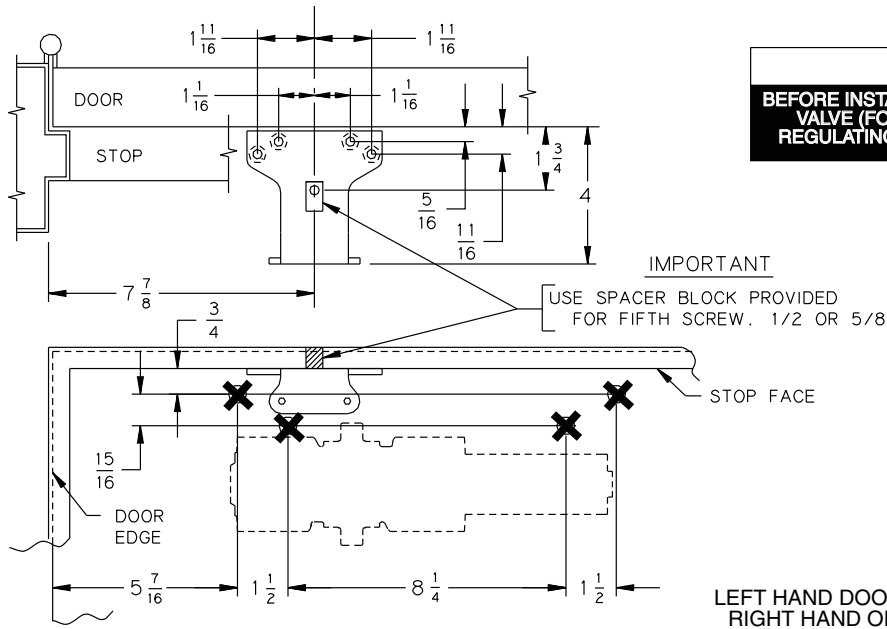

IMPORTANT
BEFORE INSTALLING CLOSER, TURN BACKCHECK SELECTOR VALVE (FOUND ON OPPOSITE SIDE OF CLOSER FROM REGULATING SCREW SIDE) ALL THE WAY IN (CLOCKWISE)

Locate drop plate & shoe from centerline of pivot or swing clear hinge pin when used.

4041PA DELAY PUSH SIDE (DOOR MOUNT) DROP PLATES

**PUSH SIDE MOUNT ON:
4040-18PA DROP PLATE
4040-18PADS1 DROP PLATE**

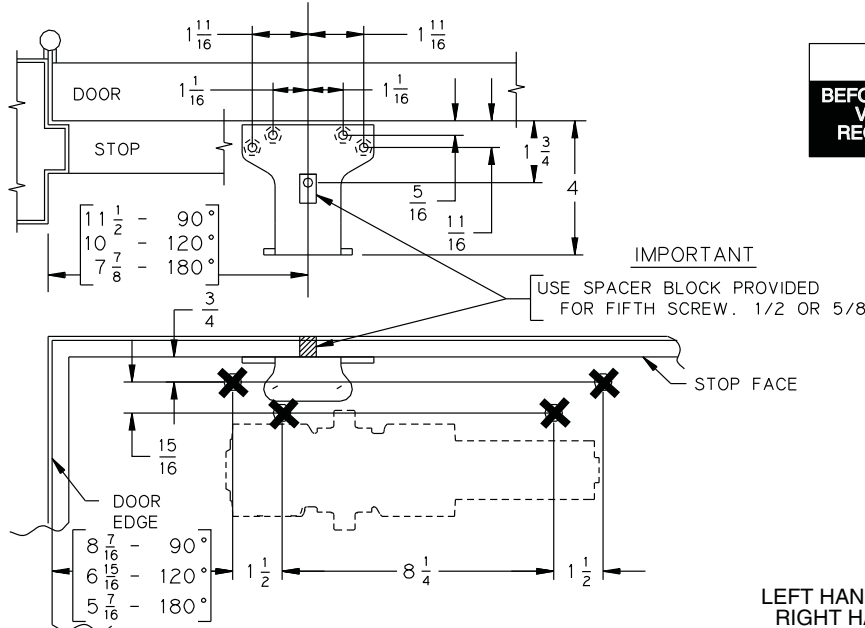

IMPORTANT
BEFORE INSTALLING CLOSER, TURN BACKCHECK SELECTOR VALVE (FOUND ON OPPOSITE SIDE OF CLOSER FROM REGULATING SCREW SIDE) ALL THE WAY IN (CLOCKWISE)

Locate drop plate & shoe from centerline of pivot or swing clear hinge pin when used.

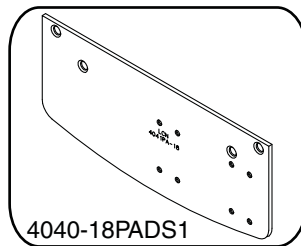
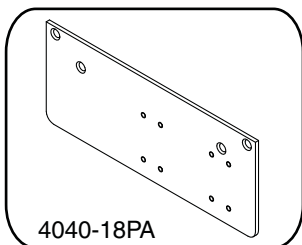

INCH	5/16	11/16	3/4	15/16	1 1/16	1 1/2	1 11/16	1 3/4
M.M.	8	17	19	24	27	38	43	44
INCH	4	5 7/16	6 15/16	7 7/8	8 1/4	8 7/16	10	11 1/2
M.M.	102	138	176	200	210	214	254	292

4041CUSH PUSH SIDE (DOOR MOUNT) DROP PLATES
PERMITS 110° MAX. OPENING, MIN. TOP RAIL 2 1/2".

PUSH SIDE MOUNT ON:
4040-18PA DROP PLATE
4040-18PADS1 DROP PLATE

IMPORTANT

BEFORE INSTALLING CLOSER, TURN BACKCHECK SELECTOR VALVE (FOUND ON OPPOSITE SIDE OF CLOSER FROM REGULATING SCREW SIDE) ALL THE WAY IN (CLOCKWISE)

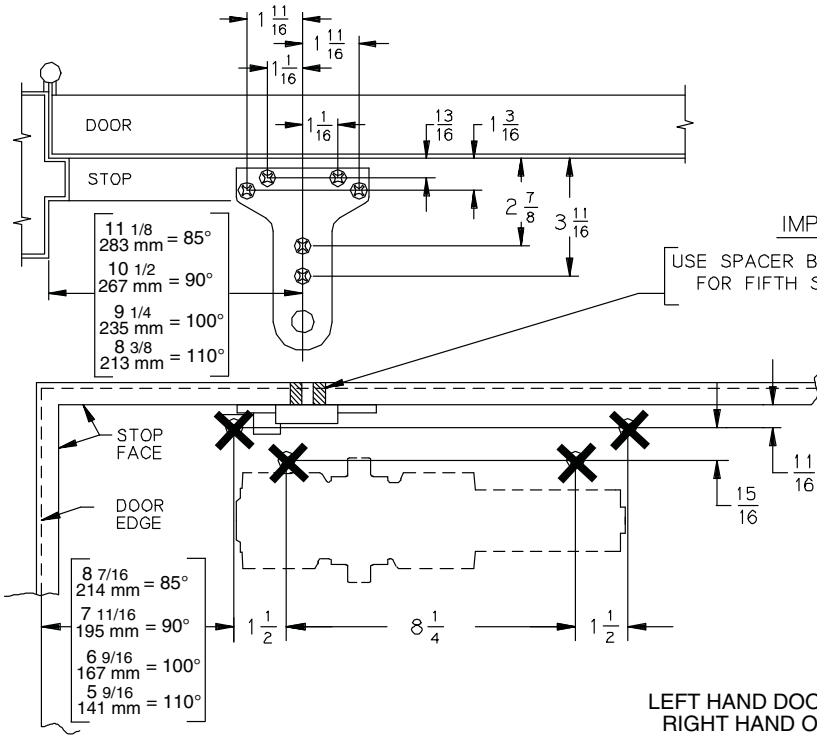

IMPORTANT

USE SPACER BLOCK PROVIDED FOR FIFTH SCREW. 1/2 OR 5/8

Locate drop plate & shoe from centerline of pivot or swing clear hinge pin when used.

LEFT HAND DOOR SHOWN, RIGHT HAND OPPOSITE.

4041EDA PUSH SIDE (DOOR MOUNT) DROP PLATES
PERMITS 180° MAX. OPENING, MIN. TOP RAIL 2 1/2".

PUSH SIDE MOUNT ON:
4040-18PA DROP PLATE
4040-18PADS1 DROP PLATE

IMPORTANT

BEFORE INSTALLING CLOSER, TURN BACKCHECK SELECTOR VALVE (FOUND ON OPPOSITE SIDE OF CLOSER FROM REGULATING SCREW SIDE) ALL THE WAY IN (CLOCKWISE)

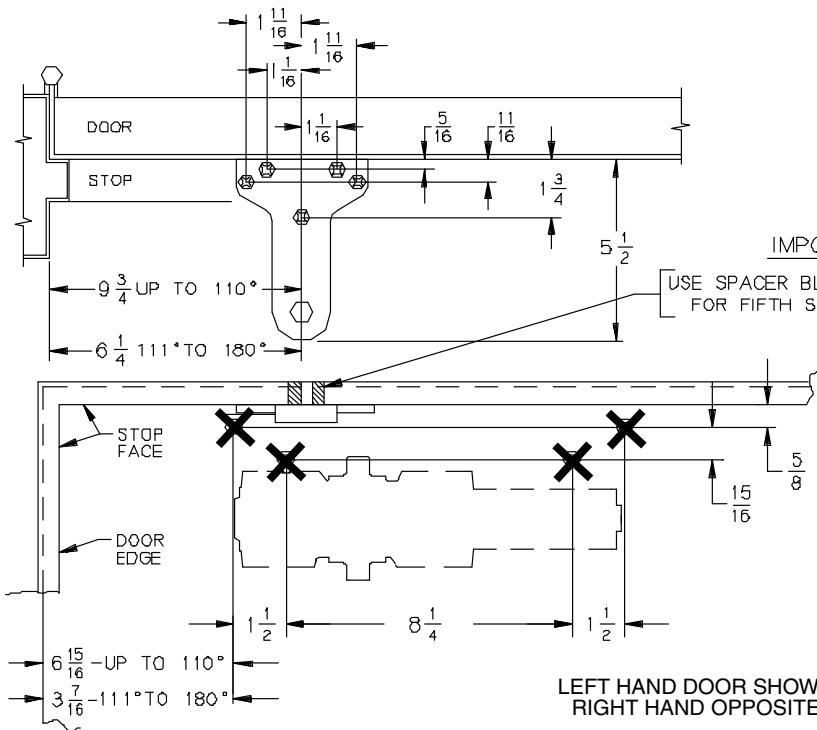

IMPORTANT

USE SPACER BLOCK PROVIDED FOR FIFTH SCREW. 1/2 OR 5/8

Locate drop plate & shoe from centerline of pivot or swing clear hinge pin when used.

LEFT HAND DOOR SHOWN, RIGHT HAND OPPOSITE.

INCH	5/16	1/2	5/8	11/16	13/16	15/16	1 1/16	1 3/16	1 1/2
M.M.	8	13	16	17	21	24	27	30	38
INCH	1 1/16	1 3/4	2 7/8	3 7/16	3 11/16	5 1/2	5 7/8	6 1/4	6 11/16
M.M.	43	44	73	87	94	140	149	159	170
INCH	6 15/16	8 1/16	8 1/4	8 9/16	8 5/8	9 1/2	9 3/4	10 13/16	11 1/4
M.M.	176	205	210	217	219	241	248	275	286

LCN[®]
 1-800-526-2400

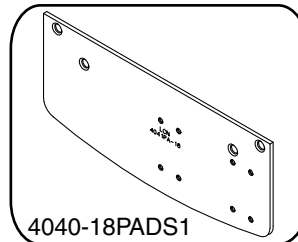
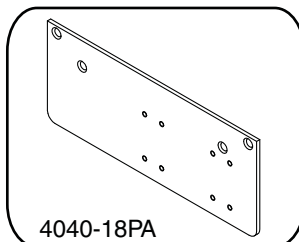

4041T PULL SIDE (DOOR MOUNT) DROP PLATES
PERMITS 120° MAXIMUM OPENING, MIN. TOP RAIL 1 13/16"

PUSH SIDE MOUNT ON:
4040-18 DROP PLATE
4040-18DS1 DROP PLATE

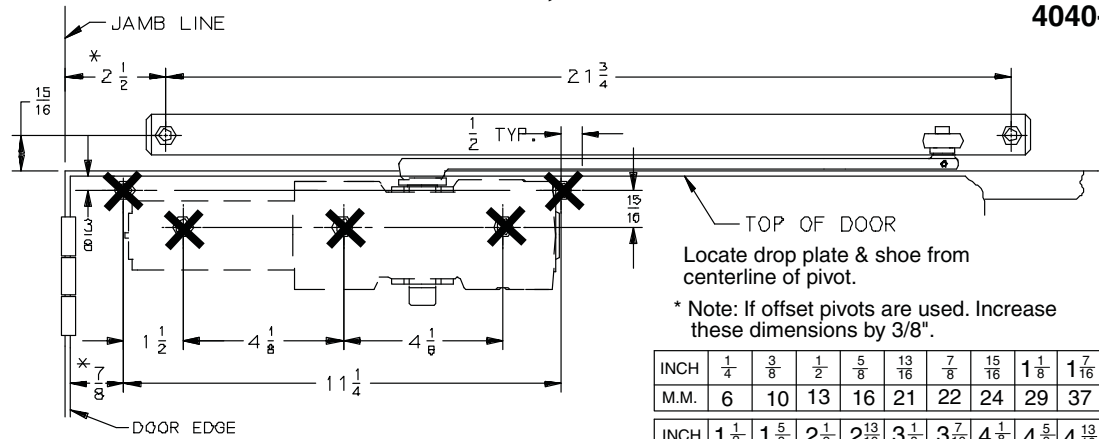

TOP OF DOOR
 Locate drop plate & shoe from centerline of pivot.

* Note: If offset pivots are used. Increase these dimensions by 3/8".

INCH	1/4	3/8	1/2	5/8	13/16	7/8	15/16	1 1/8	1 7/16
M.M.	6	10	13	16	21	22	24	29	37

INCH	1 1/2	1 5/8	2 1/2	2 13/16	3 1/8	3 7/16	4 1/8	4 5/8	4 13/16
M.M.	38	41	64	71	79	87	105	117	122

INCH	5 3/8	5 5/8	9 3/4	11 1/4	21 3/4
M.M.	137	143	248	286	553

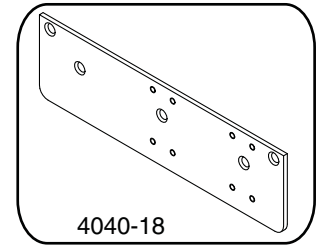

4040-18

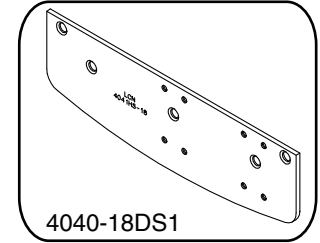

4040-18DS1

RIGHT HAND DOOR SHOWN, LEFT HAND OPPOSITE.

4041T PULL SIDE (TOP JAMB) DROP PLATES
PERMITS 180° MAXIMUM OPENING, MIN. FACE OF FRAME 1 3/4"

PUSH SIDE MOUNT ON:
4040T-18 DROP PLATE
4040T-18DS1 DROP PLATE

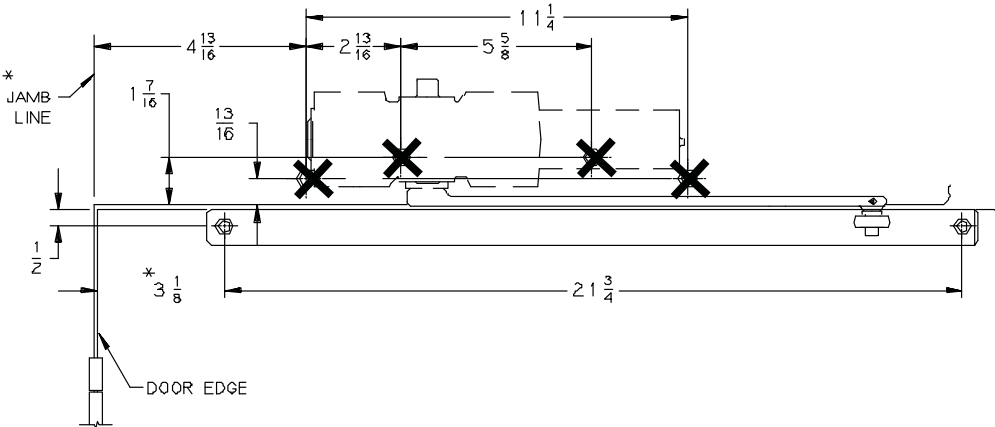

Locate drop plate & shoe from centerline of pivot or swing clear hinge pin when used.

RIGHT HAND DOOR SHOWN, LEFT HAND OPPOSITE.

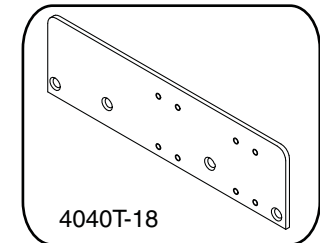

4040T-18

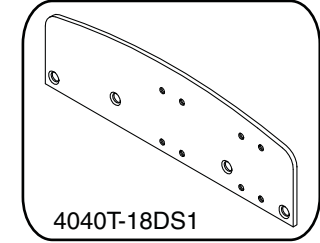

4040T-18DS1

4041T PUSH SIDE (DOOR MOUNT) DROP PLATES
PERMITS 120° MAXIMUM OPENING, MIN. TOP RAIL 2 1/4"

PUSH SIDE MOUNT ON:
4040-18PA DROP PLATE
4040-18PADS1 DROP PLATE

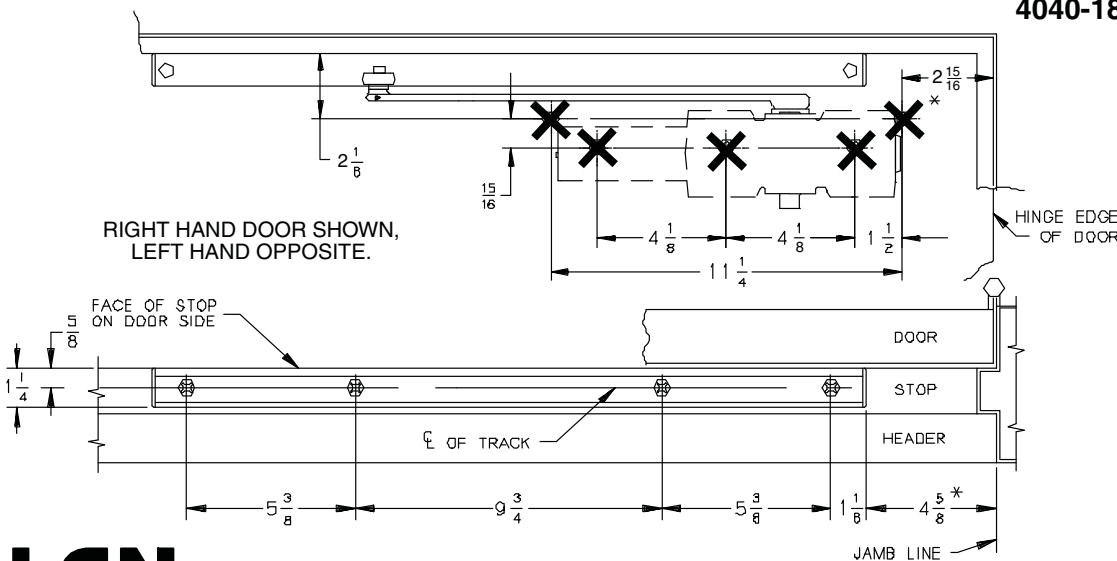

Locate drop plate & shoe from centerline of pivot or swing clear hinge pin when used.

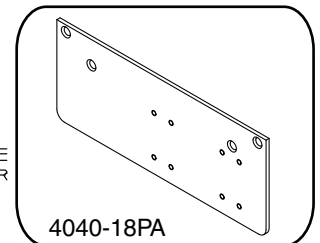

4040-18PA

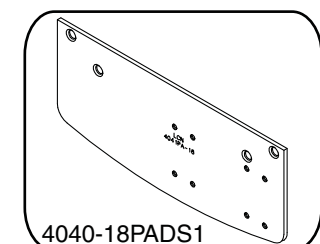

4040-18PADS1